

A

B

C

D

E

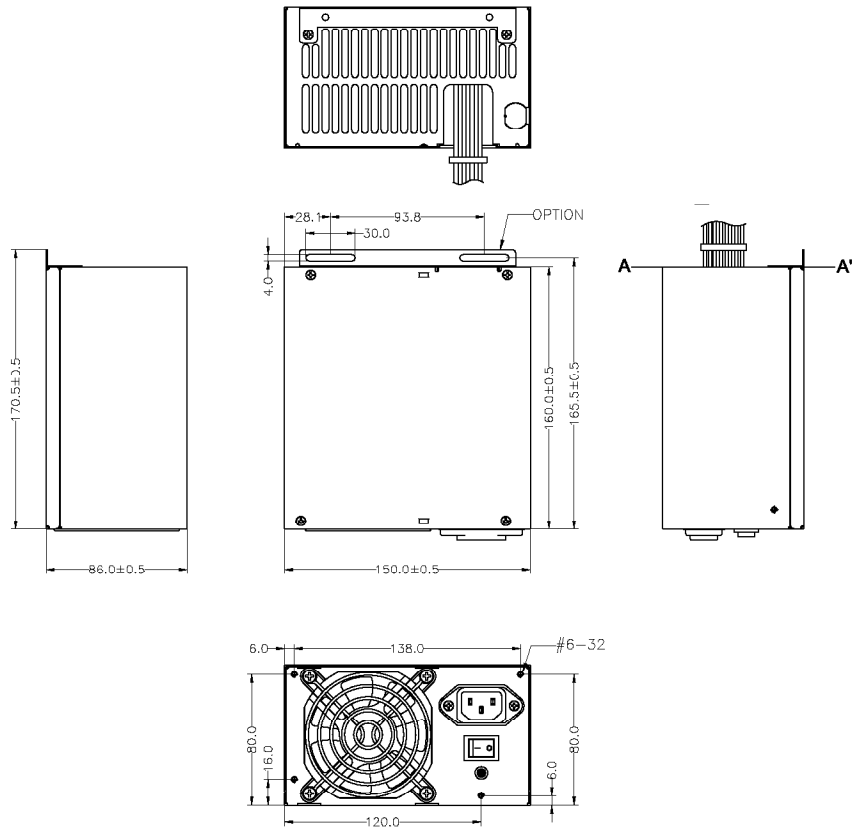

- Notes:**
- (a) All the Length of Output Wires Exclude Housing.
 - (b) PA-1~PD-2,PI Connector: TKP 870156 or EQUIV.
Cover: TKP 870156RC/870156C or EQUIV.
 - (c) PH Connector: MOLEX 39-01-2040 or EQUIV.
Terminal: MOLEX 39-00-0059 or EQUIV.
 - (d) P24 Connector: DST CH4201-220M/2 + CH4201-204M/2 or EQUIV.
Terminal: MOLEX 39-00-0059 or EQUIV.
 - (e) PX Connector: MOLEX 39-01-2200 or EQUIV.
Terminal: MOLEX 39-00-0059 or EQUIV.
 - (f) PY Connector: MOLEX 39-01-2201 or EQUIV.
Terminal: MOLEX 39-00-0040 or EQUIV.
 - (g) PJ Connector: WST P8-H42002K3 or EQUIV.
Terminal: MOLEX 39-00-0079/59 or EQUIV.

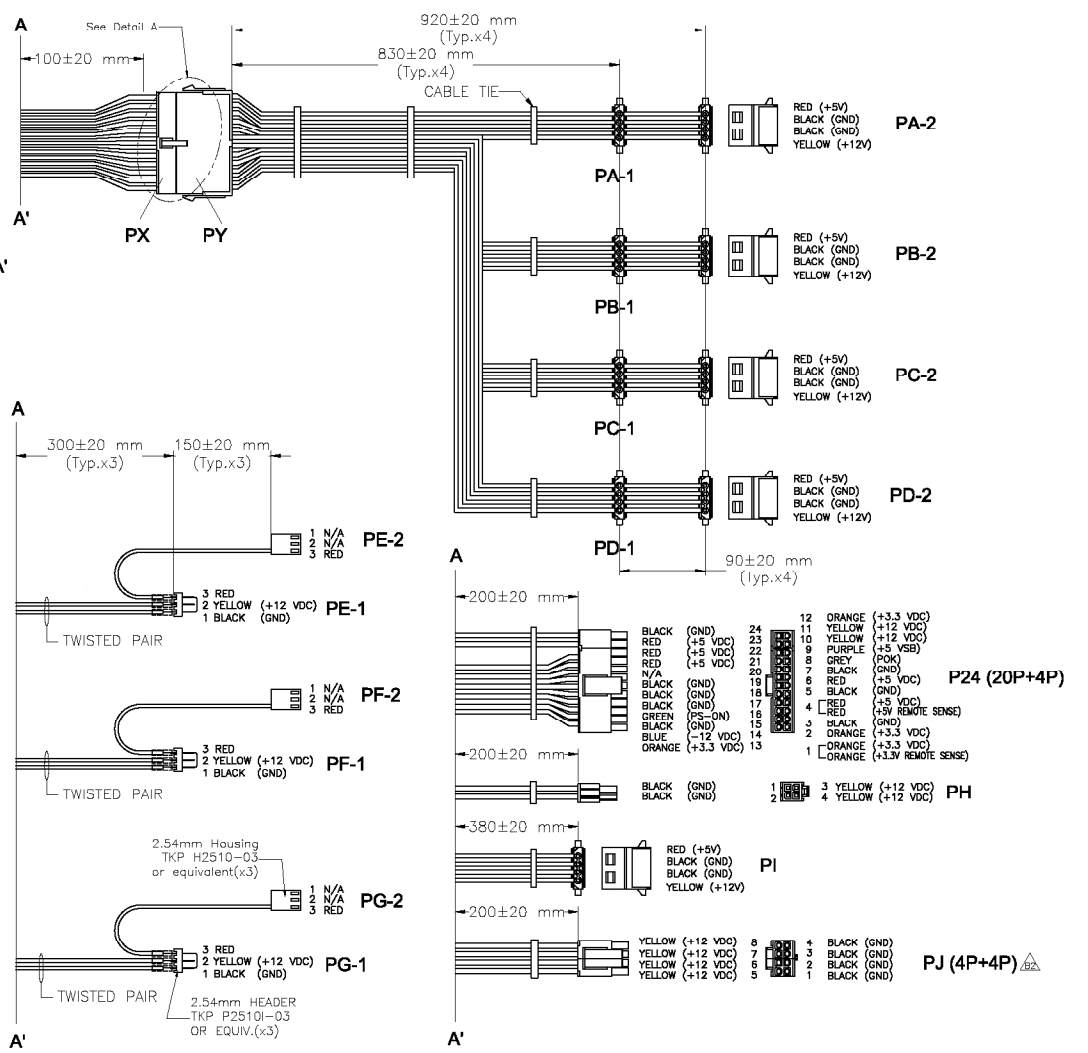

1 2 3 4 5 6 7

A

B

C

D

E

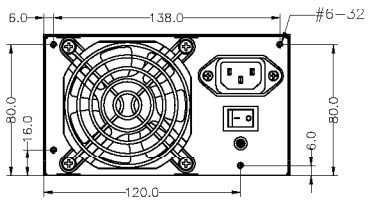
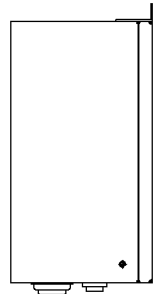
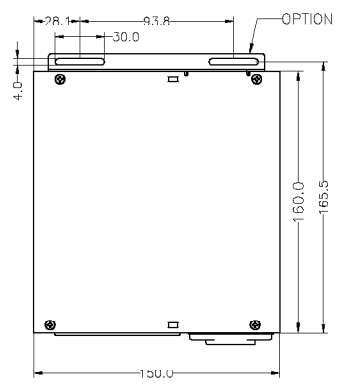
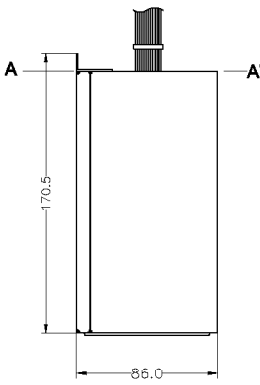
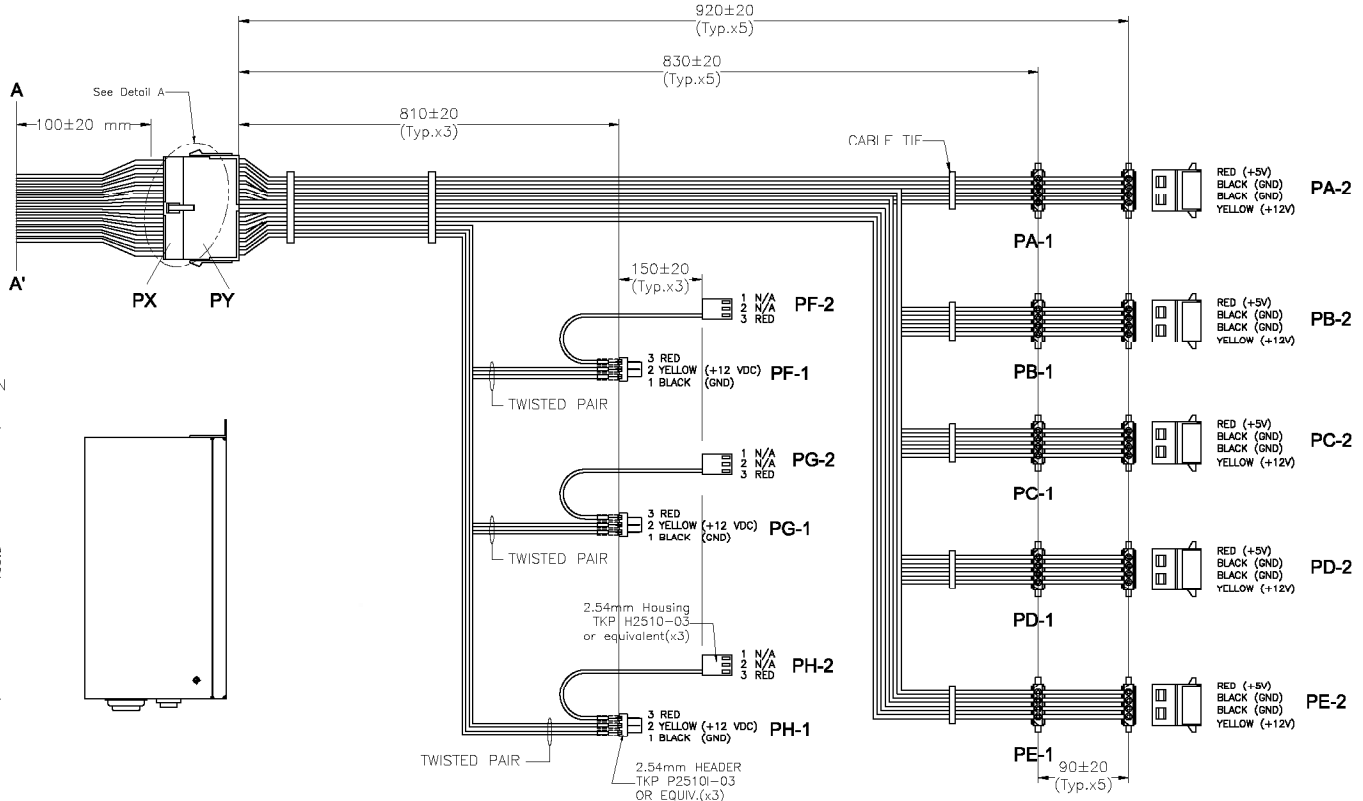
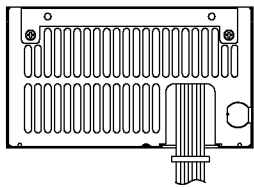

- Notes:**
- (a) All the Length of Output Wires Exclude Housing.
 - (b) PA-1~PE-2 Connector: TKP 870156 or EQUIV.
Cover: TKP 870156RC/870156C or EQUIV.
 - (c) PX Connector: MOLEX 39-01-2240 or EQUIV.
Terminal: MOLEX 39-00-0059 or EQUIV.
 - (d) PY Connector: MOLEX 39-01-2241 or EQUIV.
Terminal: MOLEX 39-00-0040 or EQUIV.